



Armadillo X2 & X3

**ABS HARDSHELL
ROOF TOP TENT**

USER MANUAL





Thank you for purchasing a 23 ZERO Roof Top Tent

Congratulations on the purchase of 23ZERO’s Armadillo X Hardshell Roof Top Tent. We strive to provide you with the ultimate camping experience. The Armadillo X Tent mounts directly to a roof rack or aftermarket roof bars. It opens and is fully setup in seconds. As well as our innovative LST fabric, this hardshell tent is made with durable materials and high-quality fabrics that provide excellent water and wind protection.

Note: During set up and first use, some aluminum shavings may be present inside the roof top tent. We make every possible attempt to expel all aluminum shavings, however, with vibrations caused by logistics some residual may dislodge and reappear. It is advised to remove and clean these during first set up.

PLEASE READ ALL INSTRUCTIONS PRIOR TO INSTALLING

IMPORTANT

Before installing your 23Zero Roof Top Tent please ensure you are aware and understand the following:

- Your vehicle’s maximum roof load rating.
- Your roof rack’s maximum load rating including off-road capacity.

The maximum amount of weight you can safely add to a vehicle’s roof / cargo area differs according to make and type of vehicle including aftermarket additions such as roof racks / bars.

Note: Roof rack off-road limits are immensely different to normal road use load ratings. If in doubt, please contact your vehicle manufacturer and roof rack manufacturer / supplier for specified loading capacity of your vehicle and roof rack.

Not all factory roof racks or aftermarket roof bars can safely accommodate roof top tent models. The responsibility of fitting this roof top tent to rated roof racks or roof bars lays with the purchaser.

CONTENTS

Safety & Warnings	-----	2
Hardware & Accessories	-----	3
Fitting to roof rack	-----	4
Ladder adjustment	-----	5
Opening & Set up	-----	6
Closing & Pack up	-----	9
Warranty	-----	12
Mounting rail dimensions	-----	13

Safety & Warnings

Improper installation or use of the Armadillo X roof top tent may result in serious injury or death. Follow these installation instructions carefully to ensure proper installation to vehicle and safe use of the roof top tent.

Note: Alterations and / or inclusions such as roof racks and roof top tents applied to the vehicle roof may affect vehicle handling and characteristics.

The manufacturer (23ZERO) disclaims all responsibility in case of accidents and / or damage due to installation of a roof top tent to an underrated roof rack, improper use, improper maintenance or checking the tightness of the brackets regarding the installation of the roof rack system.

Inspections: Roof top tents have many moving parts, so maintenance checks are always advised. During trips regularly check that all nuts and bolts attaching the roof top tent to the vehicle as well as hinges and locks are tight and in good repair.

Ladder: For your safety and protection, ensure correct placement and angle of ladder. Recommended ladder placement is a 4:1 ratio or approx. 75°.

Ladder height may need to be adjusted depending on vehicle height, see “Ladder Adjustment”

DO NOT CLIMB ON LADDER UNTIL CORRECT ANGLE IS ACHIEVED

23Zero - The wholesaler / manufacturer shall not be liable for special, indirect incidental or consequential damages.

 **SAFETY WARNING** 
KEEP ALL FLAME AND HEAT SOURCES AWAY FROM THE TENT MATERIALS.
UNDER NO CIRCUMSTANCE SHOULD ANY NAKED FLAME SOURCES OR HEATING DEVICES
BE USED INSIDE OR NEAR THE TENT.
KEEP CAMP FIRES WELL AWAY FROM TENT.
KEEP A LOOK OUT FOR ANY AIRBORNE BURNING EMBERS THAT MAY COME INTO
CONTACT WITH THE TENT.
KEEP A FIRE EXTINGUISHER OR WATER BUCKET NEARBY.
DO NOT SMOKE WITHIN THE TENT.
DO NOT OPERATE ANY DEVICE WHICH BURNS FUEL INSIDE OF THE TENT.
KEEP EXIT CLEAR.

Hardware & Accessories

The Armadillo X Hardshell roof top tent includes a mounting kit with everything required to mount the roof top tent to most roof racks.

<p>55mm M8 bolt x 8</p> 	<p>Slide plates x 8</p> 
<p>M8 <u>Nylok</u> nut x 8</p> 	<p>Mounting plate x 4</p> 
<p>Mounting rail plastic cap x 4</p> 	<p>Keys x 4</p> 
<p>Stay poles x 4</p> 	<p>13mm Ratchet <u>spanner</u></p> 

Fitting to roof rack

The Armadillo roof top tent can be fitted in either direction (opening to to the left or the right) depending on your purchase. Clamp 4 corners using 8 x 55mm M8 Bolts with slides & 4 x mounting plates supplied.

Lift roof top tent on top of the vehicle's roof rack (minimum 4-person lift).

Important: Ensure the Armadillo is closed and locked in position.

Fit 8 x 55mm M8 bolts into 8 x slide plates and slide each into bottom mounting rail. Position these so there are 2 sets of bolts in each corner of the tent. Lift / tilt the roof top tent to allow the inner bolts to cross over onto the inside of the roof bars. See pic below.

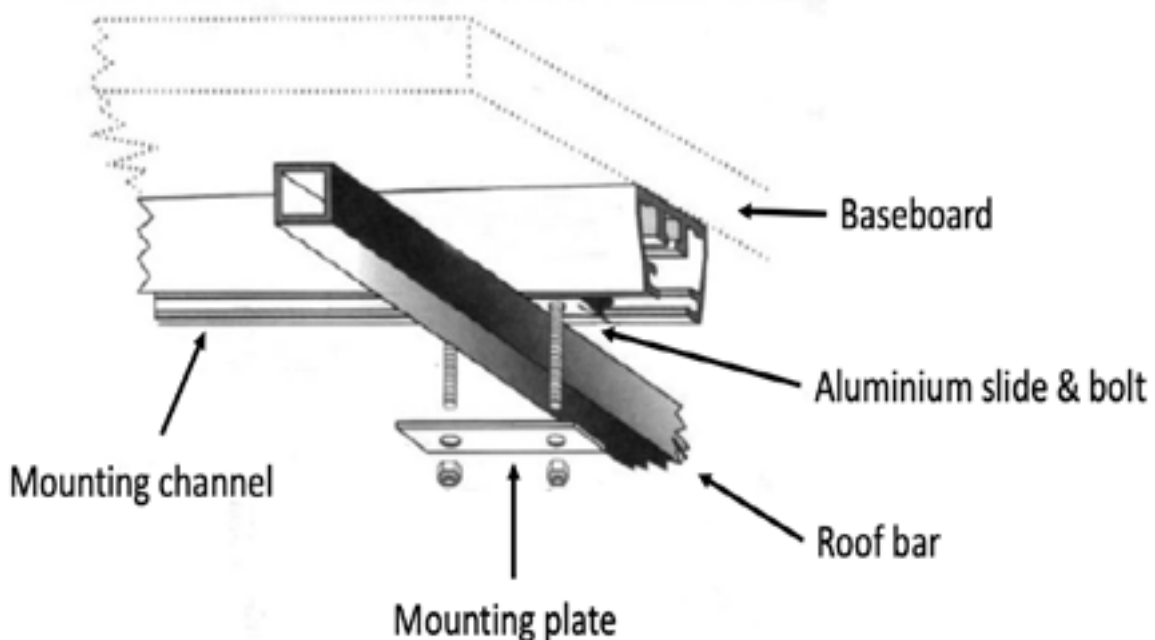

Inspect the position of the roof top tent to ensure it will open in the desired position. Place a mounting plate under the roof bar whilst locating the bolts and hand tighten lock nut. Repeat for all 4 corners. Double check the tent's position as desired and tighten all nuts securely with 13mm wrench. Insert end caps into the ends of the mounting rails, this may require light taps with a hammer.

IMPORTANT: Before using the Armadillo X, all bolts / fasteners used to mount the tent to vehicle or trailer must be re-checked for tightness and good repair including factory fitted mounting rail bolts under the mattress (top nut in diagram above). Lift mattress to check.

Inspections: Roof top tents have many moving parts so maintenance checks are always advised. During trips regularly check that all the above fixings are tight and in good repair.

Ladder adjustment

For your safety and protection, ensure correct placement and angle of ladder. See diagrams below. Recommended ladder placement is a 4:1 ratio or approx. 70° to 75°.

NOTE: Under no circumstances should anyone be inside the roof top tent if the ladder is not locked and secured at the correct angle.



The ladder may need to be adjusted to achieve the correct angle depending on the height of your setup. If shortening is required, the adjustment must be done from the top.

Ensure the ladder is fully extended and all rungs are locked in place. Press the first set of locking buttons (second rung from the top) and allow the ladder to compress until a gap of approx. 85mm is achieved between rung 1 & 2.

Note: The ladder will only lock in the downward position.

Swing in the bottom of the ladder until it supports the weight of the roof top tent. If the angle of the ladder is between 70° and 75°, the adjustment is complete.

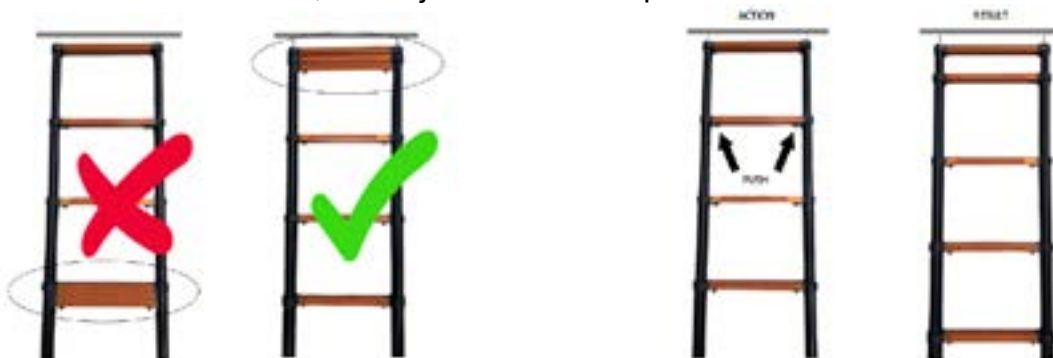

If further shortening is required press the second set of locking buttons (third rung from the top). This will close the 85mm gap until rung 1 & 2 are now touching. Swing in the bottom of the ladder until it supports the weight of the roof top tent. If the angle of the ladder is between 70° and 75°, this adjustment is complete.

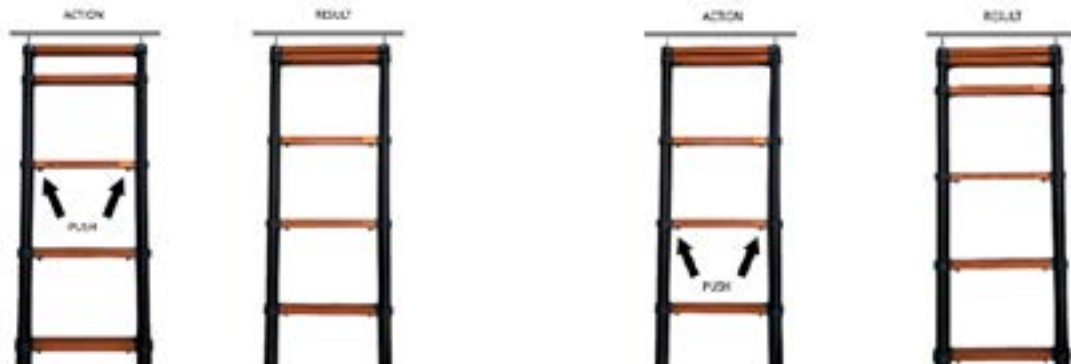

NOTE: When height adjusted, the ladder will only lock in the downward position.

If further adjustment is required, repeat the above steps by continuing the sequence by depressing the next set of locking buttons.

Opening & Set up

1. Locate locking straps. Press cam to release tension, lift lock and unhook strap.
Repeat all 4 corners.

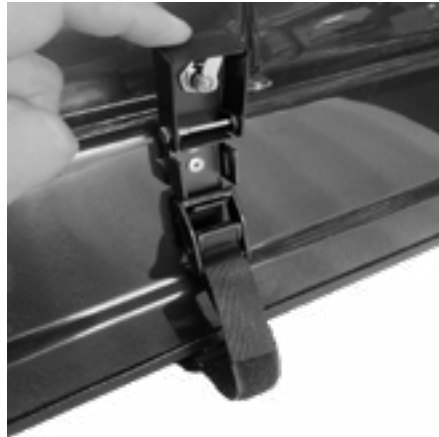

2. Lift ABS lid until gas struts takeover.
Lower pack up assisting shock cord and attach to retainer on each corner of baseboard.



3. Release ladder strap and extend ladder fully.
Using ladder as a lever, pull down & out to unfold inner baseboard.



Opening & Set up



4. **IMPORTANT:** Set and secure ladder before proceeding. See “Ladder adjustment” - page 5
5. Release canopy hoop trigger locks to extend canopy hoop. Lock to fix. Repeat other side.

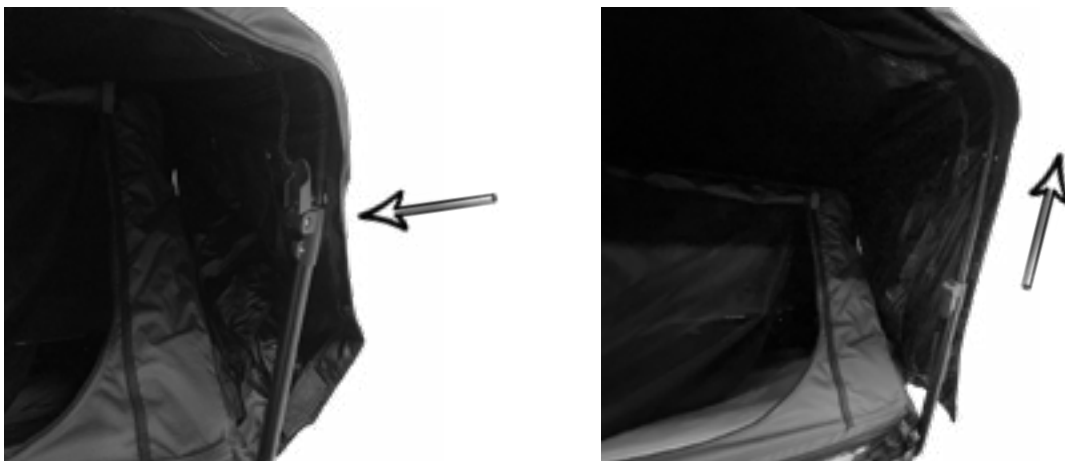

3. Attach fly to canopy pole via hook & loop wrap and to tent body via hook & loop side strip. Repeat for both sides.

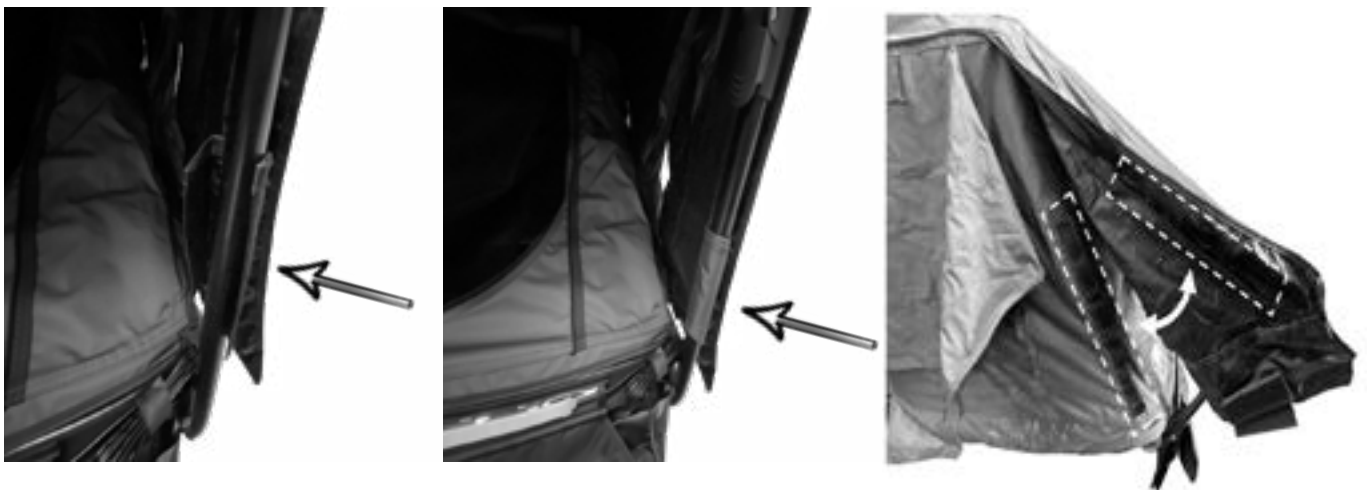

Opening & Set up

3. Locate window stay pole holes on baseboard and insert window stay poles. Flex pole and feed hook end through eyelet on window canopy. Repeat both sides.

TIP: This can be done through windows from inside tent.



Closing & Pack up

1. Bedding can be left in the Armadillo X. Before closing, fold all bedding and stow neatly against back wall.



Bedding will stow here when closed

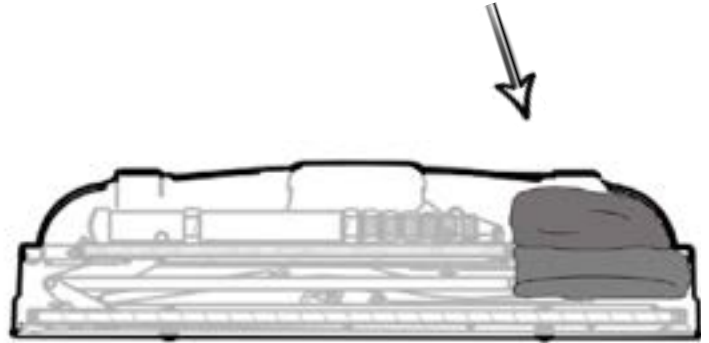

NOTE: The amount of bedding left in tent may affect closure. If tent is not folding and closing smoothly, bedding may be too bulky and must be removed. Forcing closure may put undue pressure on components and cause failure which will not be covered by warranty.

2. Remove all window stay rods and stow in supplied bag at the rear of the tent.

IMPORTANT: Do not leave these on counter-levered baseboard.

3. Separate fly from canopy hoop and tent body by releasing hook & loop wrap and hook & loop strip. Repeat for both sides.

Release canopy pole trigger locks and compress canopy pole.

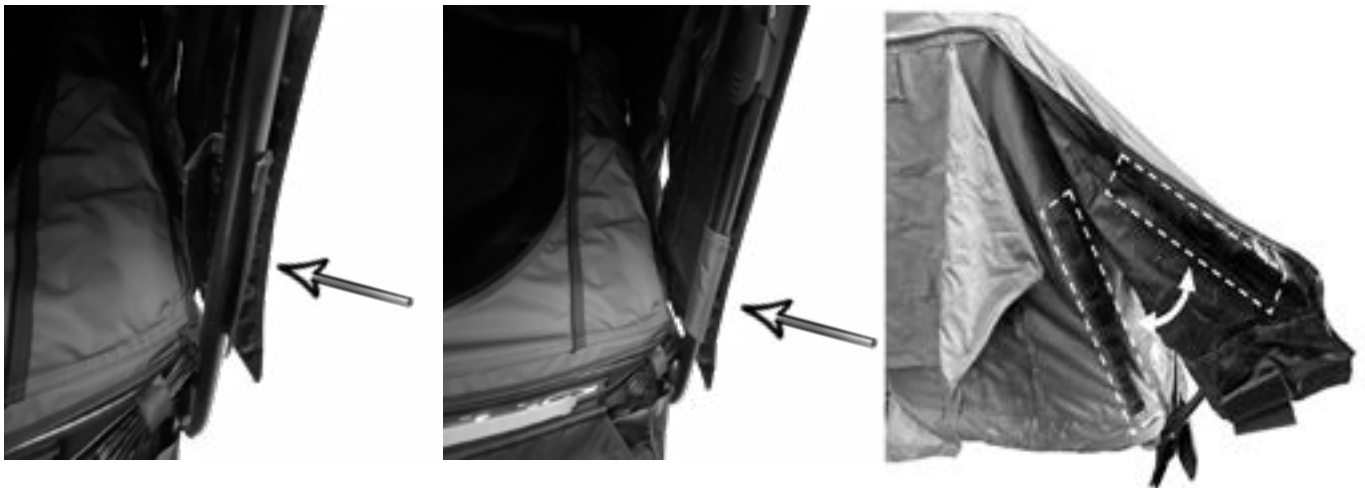

IMPORTANT! Fly must be separated from canopy pole and tent body before attempting to fold. If not separated, tent will not fold smoothly. **Do not force closure!**

NOTE: Failure to do this will put stress on components and stitching which will not be covered by warranty

Closing & Pack up

4. Use ladder to fold baseboard. **NOTE:** If ladder has been height adjust, extend fully before proceeding.



5. Retract ladder and secure with hook & loop strap. Lift shock cord and place around centre of tent ensuring all canvas is tucked inward and not flapping on sides. Lower ABS lid using attached strap. **NOTE:** Some canvas tucking may be required before completing closure. Ensure no canvas interferes with the hinge operation. Stow closing strap under lid.



Closing & Pack up

6. Once closed, hook cam buckle to locking mechanism and pull outer strap to tension until lid cannot open.
Repeat for all 4 locks.
Lock using keys provided.



Pack up complete



IMPORTANT: Ensure the Armadillo X is packed dry at all times. If weather conditions dictate a wet pack up, open the tent and allow to dry fully as soon as possible.



Warranty

23ZERO will replace or repair any product at its discretion that is subject to faulty manufacturing or workmanship including materials.

Exclusions

The above warranty is limited to manufacturing and material defects. The warranty does not cover ordinary wear and tear, damage caused by improper use, storm damage, improper cleaning, accidents, lack of general or improper maintenance, driving under car parks, hitting products against hard surfaces, damage caused by car washes, fires, sparks, abuse, alterations, animal attacks, acts of God, UV exposure, or zipper wear. This also excludes broken poles and damage caused by a jammed, snagged zipper or excessive force applied to zipper causing failure. Using 23Zero products for full-time, commercial, or rental situations voids all warranties. 23Zero reserves the right to determine quality standards under this warranty policy.

*Due to our policy of continual product development, the specifications, colors and feature may vary.

Please visit <https://23zero.com/returns/> to see full details.

Making a claim

To make a claim in relation to the above manufacturers warranty please ensure you retain your sales receipt of purchase. Please contact us stating the nature of your claim and we will be in touch with you shortly. If you require additional assistance, please call 801-349-1099 to discuss and arrange your claim. Product subject to warranty will be sent to 23ZERO USA, 2195 S Presidents Dr. Ste B. West Valley City, UT 84120. All freight costs associated with return of product for assessment is payable by the customer.

Mounting rail dimensions

The diagrams and dimensions below will assist in preparing roof racks and roof bars for fitment.

Armadillo X2

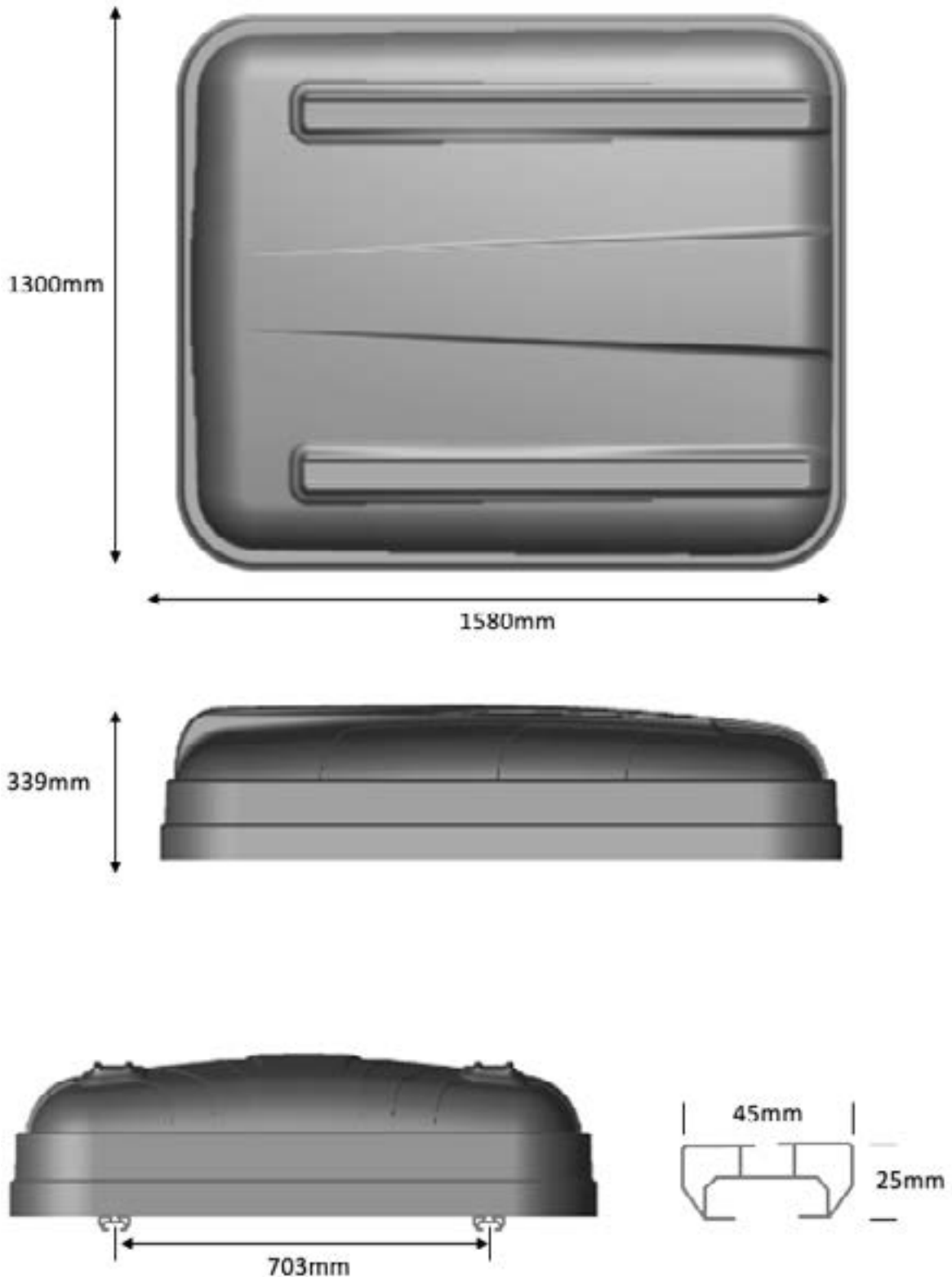

Mounting rail dimensions

The diagrams and dimensions below will assist in preparing roof racks and roof bars for fitment.

Armadillo X3

