



KABARI PRO

USER MANUAL



Thank you for purchasing a 23 ZERO Roof Top Tent

Congratulations on the purchase of 23ZERO's KABARI PRO Hardshell Roof Top Tent. We strive to provide you with the ultimate camping experience. The KABARI PRO Tent mounts directly to a roof rack or aftermarket roof bars. It opens and is fully setup in seconds. As well as our innovative LST fabric, this hardshell tent is made with durable materials and high-quality fabrics that provide excellent water and wind protection.

Most of the components have been pre-assembled. Depending on vehicle set up and choice of entry points, these components can be repositioned to suit.

Note: During set up and first use, some aluminum shavings may be present inside the roof top tent. We make every possible attempt to expel all aluminum shavings, however, with vibrations caused by logistics some residual may dislodge and reappear. It is advised to remove and clean these during first set up.

PLEASE READ ALL INSTRUCTIONS PRIOR TO INSTALLING

IMPORTANT

Before installing your 23Zero Roof Top Tent please ensure you are aware and understand the following:

- Your vehicle's maximum roof load rating.
- Your roof rack's maximum load rating including off-road capacity.

The maximum amount of weight you can safely add to a vehicle's roof / cargo area differs according to make and type of vehicle including aftermarket additions such as roof racks / bars.

Note: Roof rack off-road limits are immensely different to normal road use load ratings. If in doubt, please contact your vehicle manufacturer and roof rack manufacturer / supplier for specified loading capacity of your vehicle and roof rack.

Not all factory roof racks or aftermarket roof bars can safely accommodate roof top tent models. The responsibility of fitting this roof top tent to rated roof racks or roof bars lays with the purchaser.

Safety & Warnings

Improper installation or use of the KABARI PRO roof top tent may result in serious injury or death. Follow these installation instructions carefully to ensure proper installation to vehicle and safe use of the roof top tent.

Note: Alterations and / or inclusions such as roof racks and roof top tents applied to the vehicle roof may affect vehicle handling and characteristics.

The manufacturer (23ZERO) disclaims all responsibility in case of accidents and / or damage due to installation of a roof top tent to an underrated roof rack, improper use, improper maintenance or checking the tightness of the brackets regarding the installation of the roof rack system.

Inspections: Roof top tents have many moving parts, so maintenance checks are always advised. During trips regularly check that all nuts and bolts attaching the roof top tent to the vehicle as well as hinges and locks are tight and in good repair.

Note: The KABARI PRO Roof top tent must be locked when vehicle is in motion.

Ladder: For your safety and protection, ensure correct placement and angle of ladder. Recommended ladder placement is a 4:1 ratio or approx. 75°.

Ladder height may need to be adjusted depending on vehicle height, see "Ladder Adjustment"

DO NOT CLIMB ON LADDER UNTIL CORRECT ANGLE IS ACHIEVED

23Zero - The wholesaler / manufacturer shall not be liable for special, indirect incidental or consequential damages.



SAFETY WARNING



KEEP ALL FLAME AND HEAT SOURCES AWAY FROM THE TENT MATERIALS.

UNDER NO CIRCUMSTANCE SHOULD ANY NAKED FLAME SOURCES OR HEATING DEVICES

BE USED INSIDE OR NEAR THE TENT.

KEEP CAMP FIRES WELL AWAY FROM TENT.

KEEP A LOOK OUT FOR ANY AIRBORNE BURNING EMBERS THAT MAY COME INTO CONTACT WITH THE TENT.

KEEP A FIRE EXTINGUISHER OR WATER BUCKET NEARBY.

DO NOT SMOKE WITHIN THE TENT.

DO NOT OPERATE ANY DEVICE WHICH BURNS FUEL INSIDE OF THE TENT.

KEEP EXIT CLEAR.

Hardware & Accessories

The KABARI PRO Hardshell roof top tent includes a mounting kit with everything required to mount the roof top tent to most roof racks.

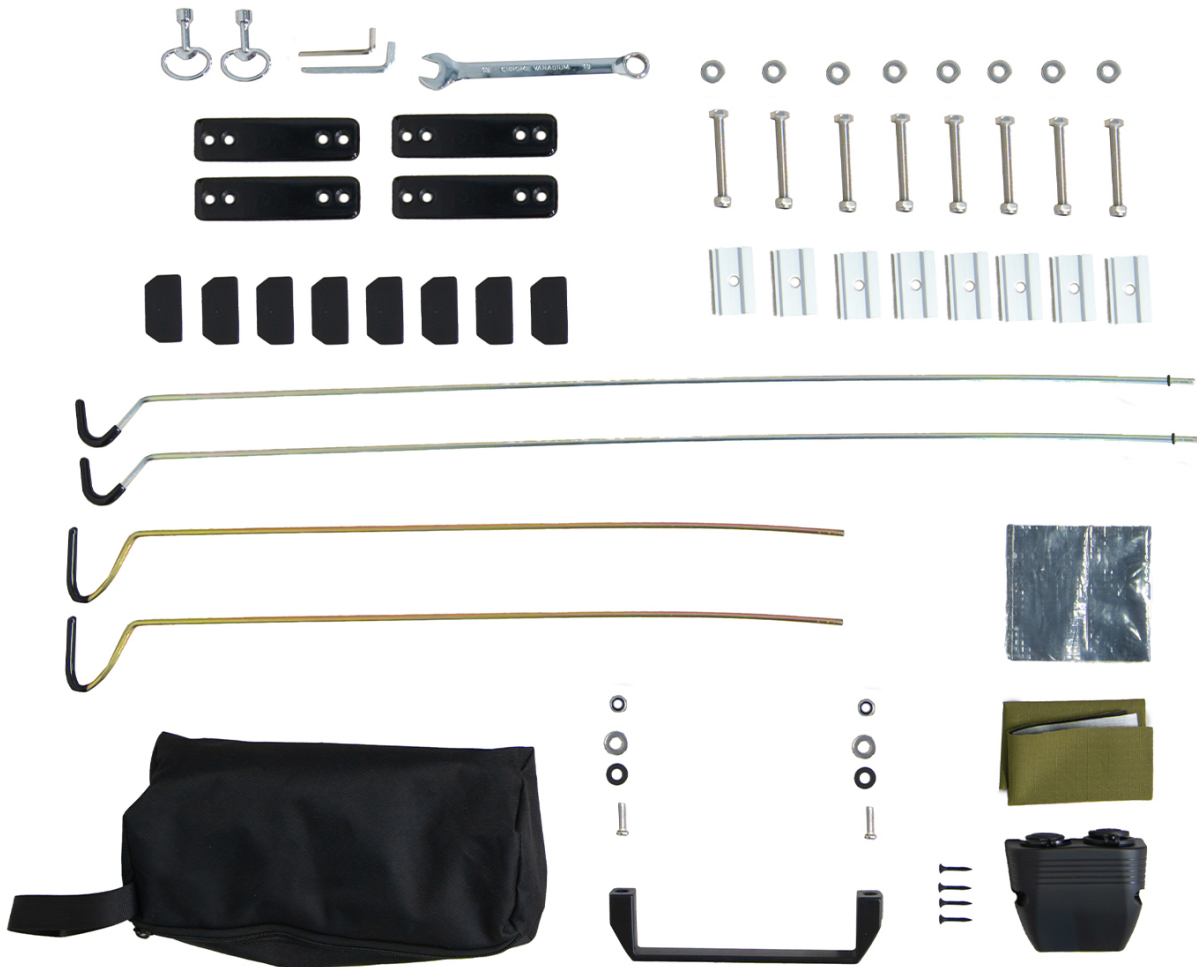

Fitting to roof rack

The KABARI PRO roof top tent must be fitted to roof racks with the hinges facing forward (front of vehicle). It must be clamped on 4 corners using the mounting bolts & mounting plates supplied. To do this, place the roof top tent on top of the vehicle's roof rack (minimum 4-person lift).

Important: Ensure the KABARI PRO is locked during installation to avoid accidental opening.

Any of the pre fitted mounting rails can be used to mount the KABARI PRO roof top tent to the roof rack. Fit the mounting bolts into 8 x slide plates and slide each into bottom mounting rails. Position these so there are 2 sets of bolts in each corner of the tent. Lift / tilt the roof top tent to allow the inner bolts to cross over onto the inside of the roof bars.

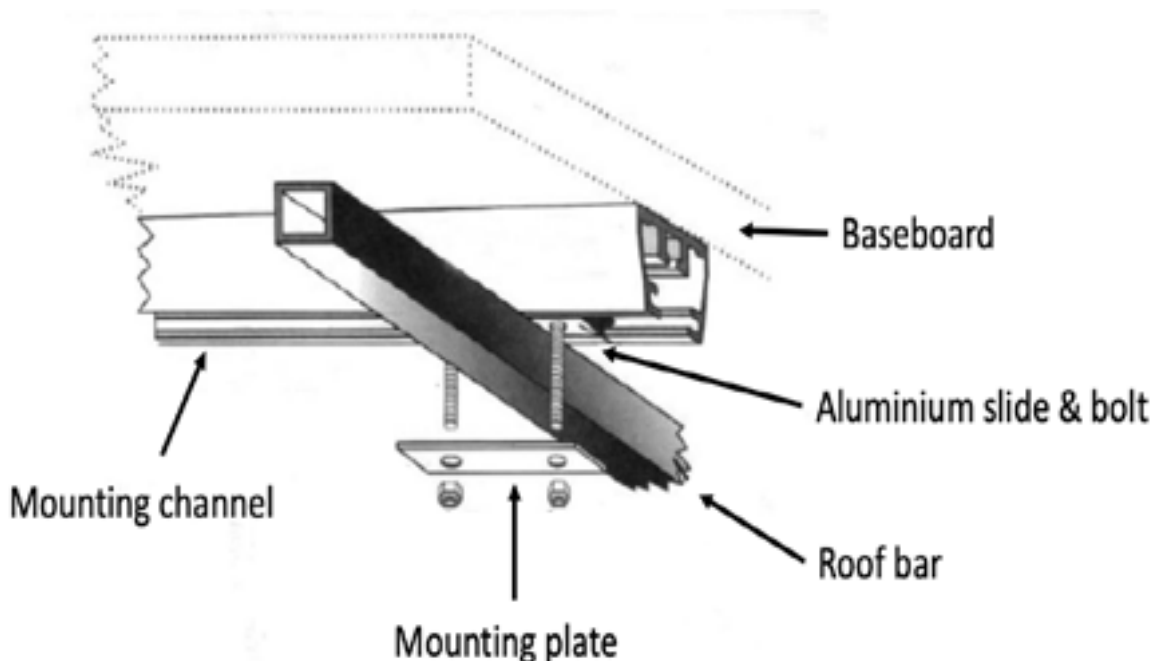

Inspect the position of the roof top tent to ensure it will open in the desired position.

Note: It is recommended the rear of the tent is flush with the back of the vehicle to allow correct ladder angle. Place a mounting plate under the roof bar whilst locating the bolts, insert washer and hand tighten lock nut. Repeat for all 4 corners. Double check the tent's position as desired and tighten all nuts securely with 13mm wrench. Insert end caps into the ends of the mounting rails, this may require light taps from a hammer.

Inspections: Roof top tents have many moving parts so maintenance checks are always advised. During trips regularly check that all the above fixings are tight and in good repair.

Ladder adjustment

For your safety and protection, ensure correct placement and angle of ladder. See diagrams below. Recommended ladder placement is a 4:1 ratio or approx. 70° to 75°.

NOTE: Under no circumstances should anyone be inside the roof top tent if the ladder is not locked and secured at the correct angle.



The ladder may need to be adjusted to achieve the correct angle depending on the height of your setup. If shortening is required, the adjustment must be done from the top.

Ensure the ladder is fully extended and all rungs are locked in place. Press the first set of locking buttons (second rung from the top) and allow the ladder to compress until a gap of approx. 85mm is achieved between rung 1 & 2.

Note: The ladder will only lock in the downward position.

Swing in the bottom of the ladder until it supports the weight of the roof top tent. If the angle of the ladder is between 70° and 75°, the adjustment is complete.

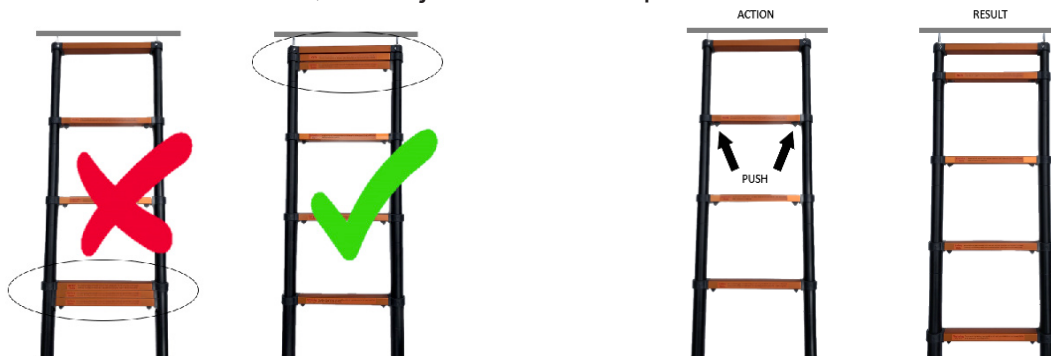

If further shortening is required press the second set of locking buttons (third rung from the top). This will close the 85mm gap until rung 1 & 2 are now touching. Swing in the bottom of the ladder until it supports the weight of the roof top tent. If the angle of the ladder is between 70° and 75°, this adjustment is complete.

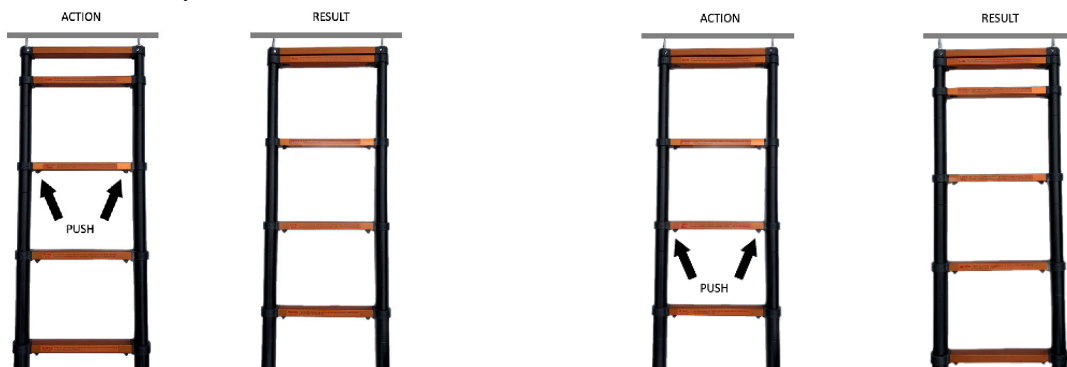

NOTE: When height adjusted, the ladder will only lock in the downward position.

If further adjustment is required, repeat the above steps by continuing the sequence by depressing the next set of locking buttons.

Opening & Set up

Once the KABARI PRO is fixed securely to the vehicle's roof rack and the ladder is locked and angled correctly, climb the ladder, release the locks on either side of the tent and lift until the gas struts take over.

Once open, lower the perimeter shock cord and hook this to both front corners of the baseboard.

Push the internal hoop out and install the telescoping support. Attach the clamp to the internal hoop and run the pole through the ceiling loop and extend until taut against the ceiling.

Locate and deploy the spring poles. The short poles go on the side brackets, while the long poles go in the rear brackets. Fit each of these into their brackets with the hook end facing outward. Flex each pole and insert the hook ends into the eyelets on the corners of the canopy. Note: Side poles are only needed if rain fly clips are released.

Closing & Storage

Sleeping bags or blankets can be stored in the KABARI PRO if laid out flat. Do not over pack bedding. Not only do these make closing the tent difficult but they will put excessive pressure on hinges which may lead to failures and damage. This damage is distinguishable and is not covered by warranty.

Release and remove the telescoping pole from the ceiling and pivot the internal hoop so it is laying inside the tent.

Tip: If stowing pillows inside the KABARI PRO, move them toward the hinge end before closing the tent.

Tip: Leave the side windows open halfway open to allow internal air to escape while closing the tent.

As the KABARI PRO is closing, tuck the canvas inside so none is caught between the sealing rubbers on the roof lid and baseboard. Engage the locks. Unhook the ladder, retract and stow in carry bag.

Caution: Avoid closing / storing tent wet. If conditions dictate that you do, open and dry out as soon as possible to avoid moisture damage.

Internal Power Installation

Step 1: Gather Your Components

Locate the box containing the power box, wiring, and Anderson plug.



Step 2: Disconnect the Anderson Plug Contacts from Housing

1. Use a flathead screwdriver or a similar tool to depress the contact pins inside the Anderson plug housing.
2. Release both sides to detach the plug from the housing.

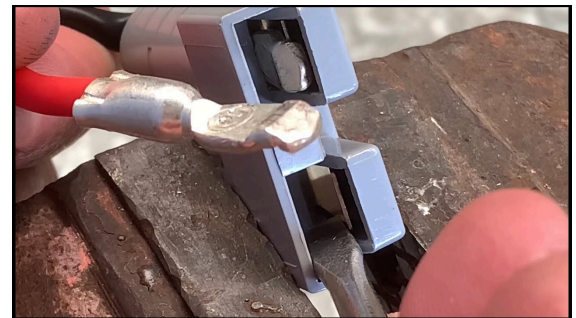

Click link for Tutorial: https://www.youtube.com/watch?v=qstOR4Uy_1o

Step 3: Feed the Wire Through the Tent

1. Unscrew the weatherproof grommet from the exterior underside of the tent.
2. From inside the tent, carefully feed the contacts through the hole. There will be some resistance as the hole is designed to be just large enough for the wire to pass through.
3. Push one contact completely through the hole until most of the wire is outside the tent. Then push the second contact through until most of the wire is outside the tent. Avoid pulling on the contacts directly—grip and pull the wire itself .

Step 4: Route the Wire and Secure the Anderson Plug

1. From outside the tent, push the wire through the weatherproof grommet (same method used when passing through the tent). Do not tighten the grommet yet—you will need to position the Anderson plug outside the tent and the power box inside before securing it.
2. Reinsert the contacts into the Anderson plug housing.
3. Attach the Anderson plug to the underside of the tent using the provided adhesive tape. Face the open end of housing to the rear to help keep debris from entering contacts.

Step 5: Secure the Power Box

1. Inside the tent, position the power box and tuck any excess wire behind it.
2. Use the provided screws to secure the power box in place.

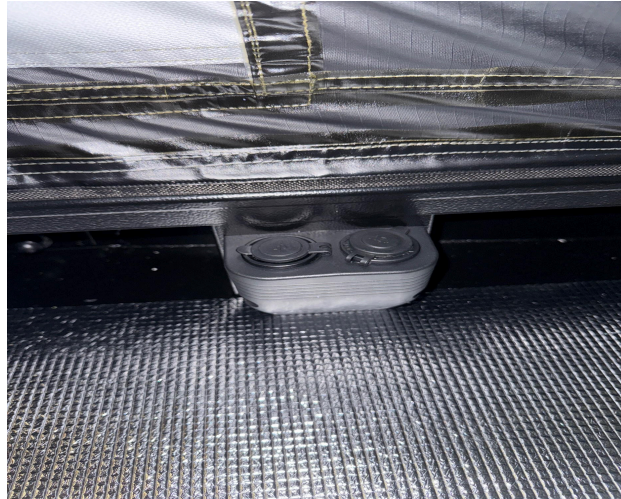
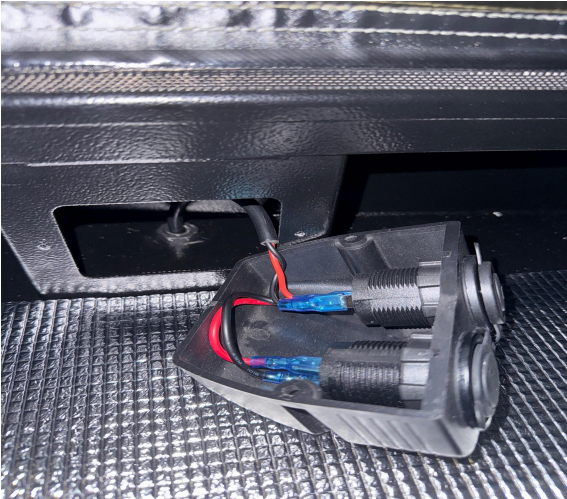

Step 6: Finalize Installation

1. Stow the excess wire properly in the cubby behind the power box.
2. Tighten the weatherproof grommet underneath the tent to secure the wiring.

*Power cable sold separately.

Warranty

23ZERO will replace or repair any product at its discretion that is subject to faulty manufacturing or workmanship including materials.

Making a claim

To make a claim in relation to the above manufacturers warranty please ensure you retain your sales receipt of purchase. Please contact us stating the nature of your claim and we will be in touch with you shortly. If you require additional assistance, please call 801-349-1099 to discuss and arrange your claim. Product subject to warranty will be sent to 23ZERO USA, 2195 S Presidents Dr. Ste B. West Valley City, UT 84120. All freight costs associated with return of product for assessment is payable by the customer.

Due to our policy of continual product development, the specifications, colors and feature may vary.

Please visit <https://23zero.com/returns/> to see full details.